

HARMONY SQUARE SUSPENSION

A51075-

base number Color Finish Diffuser
 Temperature Options Options

- To build a product code in our configurator select the specify button on the base model # product page
- To build a manual product code on this datasheet choose from the options listed below in blue font and add the suffix to the base model #

GENERAL

Series: Harmony Square
 Partner: Ivela
 Division: Architectural
 Installation: Suspension
 Product Type: Panels
 Mounting Location: Ceiling
 Light Distribution: Direct

PHYSICAL

Shape: Square
 Length (mm): 610
 Length (in): 24
 Width (mm): 610
 Width (in): 24
 Height (mm): 27
 Height (in): 1 ¹/₁₆
 Max. Overall Height (mm): 2500
 Max. Overall Height (in): 98 ⁷/₁₆
 Diffuser: [PMMA - Opal / Prismatic](#)
 Fixture Finish: [WHI / BLK / GLD](#)
 Fixture Material: Aluminum

ELECTRICAL

Lamp Type: LED
 Input Wattage (W): 48
 Dimming: Tri-Mode (Non-Dimming and Phase Dimming (120Vac only) and 0-10V Dimming)
 Driver Included: No
 Driver Location: Remote
 Driver Type: Constant Voltage - Universal
 Driver Class: Class 2
 Housing: ENCP 5 (ERP) ENCP 13 (SC Power)
 Input Voltage (V): 120 - 277
 Output Voltage (V): 24

LED

Color Temperature (°K): [2700 / 3000 / 3500 / 4000](#)
 Max. Delivered Lumen (lm): 3456 / 3600 / 3707 / 3816
 Nominal Lumen (lm): 5760 / 6000 / 6360
 CRI: >93 CRI
 Lamp Life (hrs): 50000

OPTICAL

RATINGS AND CERTIFICATIONS

Certified By: Certified for North American Standards
 IP rating: IP20



HARMONY SQUARE SUSPENSION

A51075-

PROJECT _____

TYPE _____

SPECIFIER _____

QUANTITY _____

DATE _____



PROJECT	_____
TYPE	_____
SPECIFIER	_____
QUANTITY	_____
DATE	_____

HARMONY SQUARE SUSPENSION

A51076-

base number	Color	Finish	Diffuser
	Temperature	Options	Options

- To build a product code in our configurator select the specify button on the base model # product page
- To build a manual product code on this datasheet choose from the options listed below in blue font and add the suffix to the base model #

GENERAL

Series: Harmony Square
Partner: Ivela
Division: Architectural
Installation: Suspension
Product Type: Panels
Mounting Location: Ceiling
Light Distribution: Direct

PHYSICAL

Shape: Square
Length (mm): 910
Length (in): 35 ¹³ / ₁₆
Width (mm): 910
Width (in): 35 ¹³ / ₁₆
Height (mm): 27
Height (in): 1 ¹ / ₁₆
Max. Overall Height (mm): 2500
Max. Overall Height (in): 98 ⁷ / ₁₆
Diffuser: PMMA - Opal / Prismatic
Fixture Finish: WHI / BLK / GLD
Fixture Material: Aluminum

ELECTRICAL

Lamp Type: LED
Input Wattage (W): 48
Dimming: Tri-Mode (Non-Dimming and Phase Dimming (120Vac only) and 0-10V Dimming)
Driver Included: No
Driver Location: Remote
Driver Type: Constant Voltage - Universal
Driver Class: Class 2
Housing: ENCP 5 (ERP) ENCP 8 (SC Power)
Input Voltage (V): 120 - 277
Output Voltage (V): 24

LED

Color Temperature (°K): 2700 / 3000 / 3500 / 4000
Max. Delivered Lumen (lm): 5184 / 5400 / 5560 / 5724
Nominal Lumen (lm): 8640 / 9000 / 9540
CRI: >93 CRI
Lamp Life (hrs): 50000

OPTICAL

RATINGS AND CERTIFICATIONS

Certified By: Certified for North American Standards
IP rating: IP20

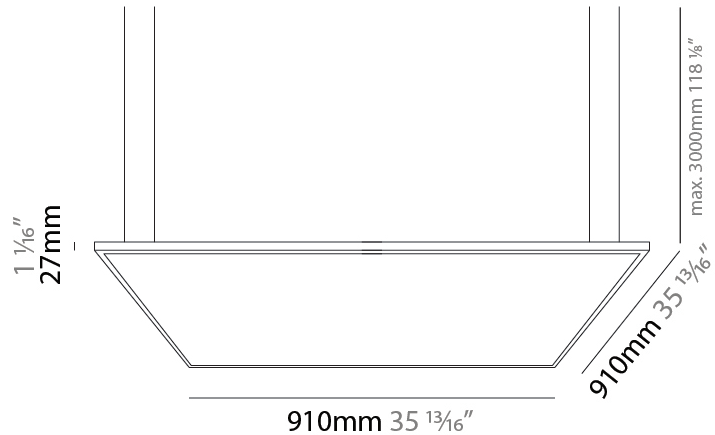

HARMONY SQUARE SUSPENSION

A51076-

PROJECT

TYPE

SPECIFIER

QUANTITY

DATE

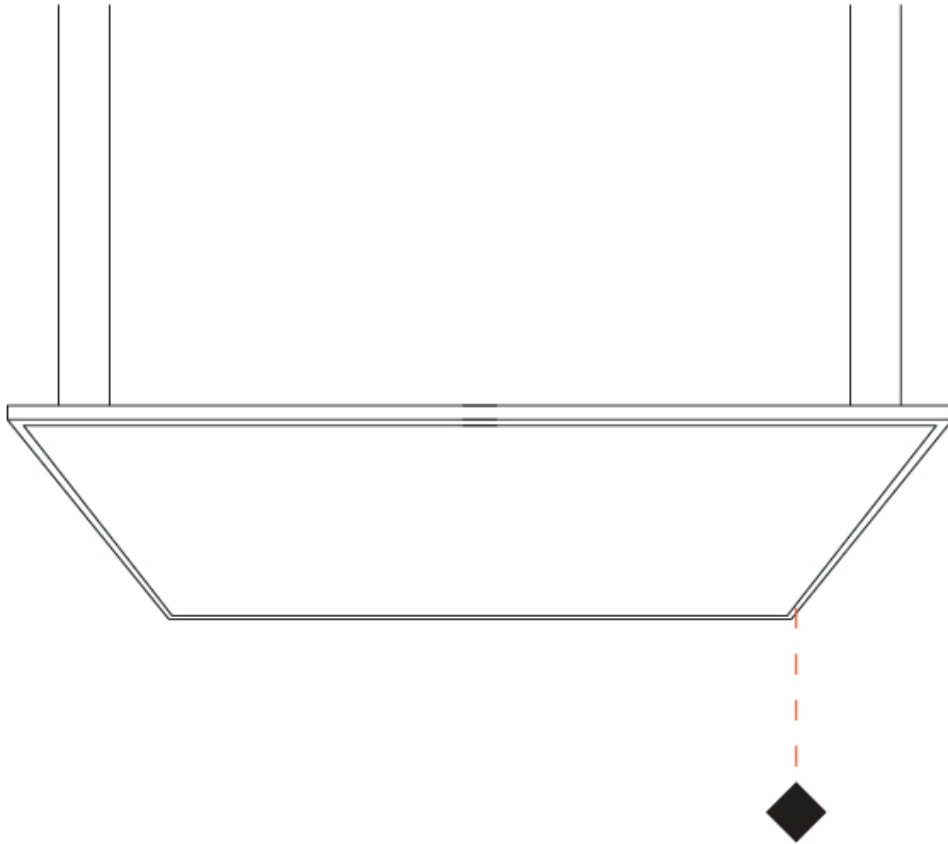

PROJECT	
TYPE	
SPECIFIER	
QUANTITY	
DATE	

HARMONY SQUARE SUSPENSION

A51077-

base number	Color	Finish	Diffuser
	Temperature	Options	Options

- To build a product code in our configurator select the specify button on the base model # product page
- To build a manual product code on this datasheet choose from the options listed below in blue font and add the suffix to the base model #

GENERAL

Series: Harmony Square
Partner: Ivela
Division: Architectural
Installation: Suspension
Product Type: Panels
Mounting Location: Ceiling
Light Distribution: Direct

PHYSICAL

Shape: Square
Length (mm): 1110
Length (in): 43 11/16
Width (mm): 1110
Width (in): 43 11/16
Height (mm): 27
Height (in): 1 1/16
Max. Overall Height (mm): 2500
Max. Overall Height (in): 98 7/16
Diffuser: PMMA - Opal / Prismatic
Fixture Finish: WHI / BLK / GLD
Fixture Material: Aluminum

ELECTRICAL

Lamp Type: LED
Input Wattage (W): 80
Dimming: Tri-Mode (Non-Dimming and Phase Dimming (120Vac only) and 0-10V Dimming)
Driver Included: No
Driver Location: Remote
Driver Type: Constant Voltage - Universal
Driver Class: Class 2
Housing: ENCP 5 (ERP) ENCP 13 (SC Power)
Input Voltage (V): 120 - 277
Output Voltage (V): 24

LED

Color Temperature (°K): 2700 / 3000 / 3500 / 4000
Max. Delivered Lumen (lm): 6336 / 6600 / 6796 / 6996
Nominal Lumen (lm): 10560 / 11000 / 11660
CRI: >93 CRI
Lamp Life (hrs): 50000

OPTICAL

RATINGS AND CERTIFICATIONS

Certified By: Certified for North American Standards
IP rating: IP20

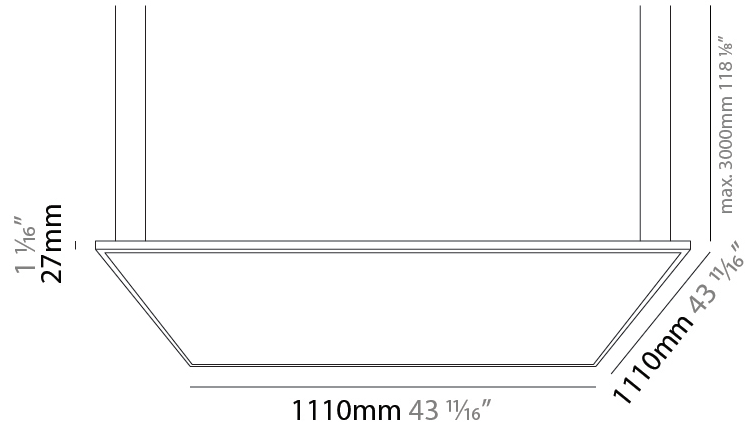

HARMONY SQUARE SUSPENSION

A51077-

PROJECT	_____
TYPE	_____
SPECIFIER	_____
QUANTITY	_____
DATE	_____

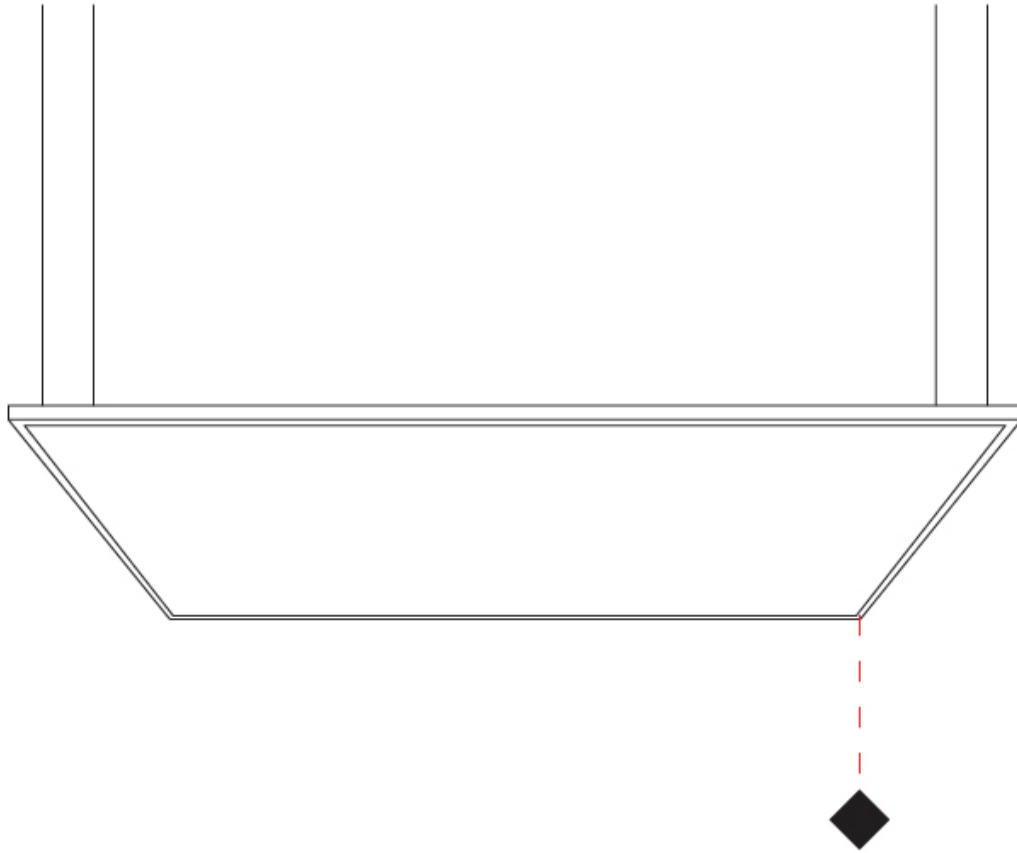

PROJECT
TYPE
SPECIFIER
QUANTITY
DATE

HARMONY SQUARE SUSPENSION

A51078-

base number	Color Temperature	Finish Options	Diffuser Options
-------------	----------------------	-------------------	---------------------

- To build a product code in our configurator select the specify button on the base model # product page
- To build a manual product code on this datasheet choose from the options listed below in blue font and add the suffix to the base model #

GENERAL

Series: Harmony Square
Partner: Ivela
Division: Architectural
Installation: Suspension
Product Type: Panels
Mounting Location: Ceiling
Light Distribution: Direct

PHYSICAL

Shape: Square
Length (mm): 1210
Length (in): 47 ⁵ / ₈
Width (mm): 610
Width (in): 24
Height (mm): 27
Height (in): 1 ¹ / ₁₆
Max. Overall Height (mm): 2500
Max. Overall Height (in): 98 ⁷ / ₁₆
Diffuser: PMMA - Opal / Prismatic
Fixture Finish: WHI / BLK / GLD
Fixture Material: Aluminum

ELECTRICAL

Lamp Type: LED
Input Wattage (W): 48
Dimming: Tri-Mode (Non-Dimming and Phase Dimming (120Vac only) and 0-10V Dimming)
Driver Included: No
Driver Location: Remote
Driver Type: Constant Voltage - Universal
Driver Class: Class 2
Housing: ENCP 5 (ERP) ENCP 13 (SC Power)
Input Voltage (V): 120 - 277
Output Voltage (V): 24

LED

Color Temperature (°K): 2700 / 3000 / 3500 / 4000
Max. Delivered Lumen (lm): 3456 / 3600 / 3707 / 3816
Nominal Lumen (lm): 5760 / 6000 / 6360
CRI: >93 CRI
Lamp Life (hrs): 50000

OPTICAL

RATINGS AND CERTIFICATIONS

Certified By: Certified for North American Standards
IP rating: IP20

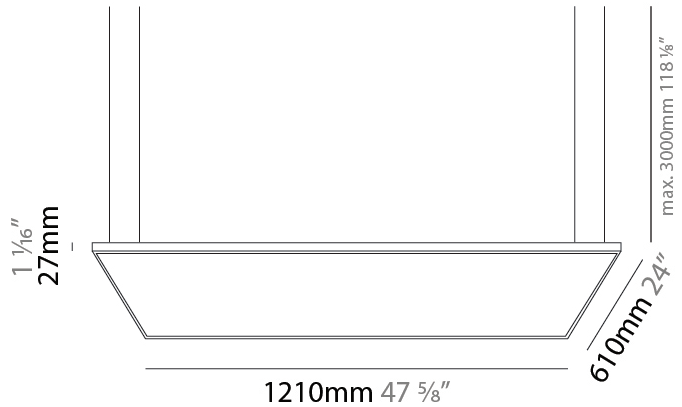

HARMONY SQUARE SUSPENSION

A51078-

PROJECT	_____
TYPE	_____
SPECIFIER	_____
QUANTITY	_____
DATE	_____

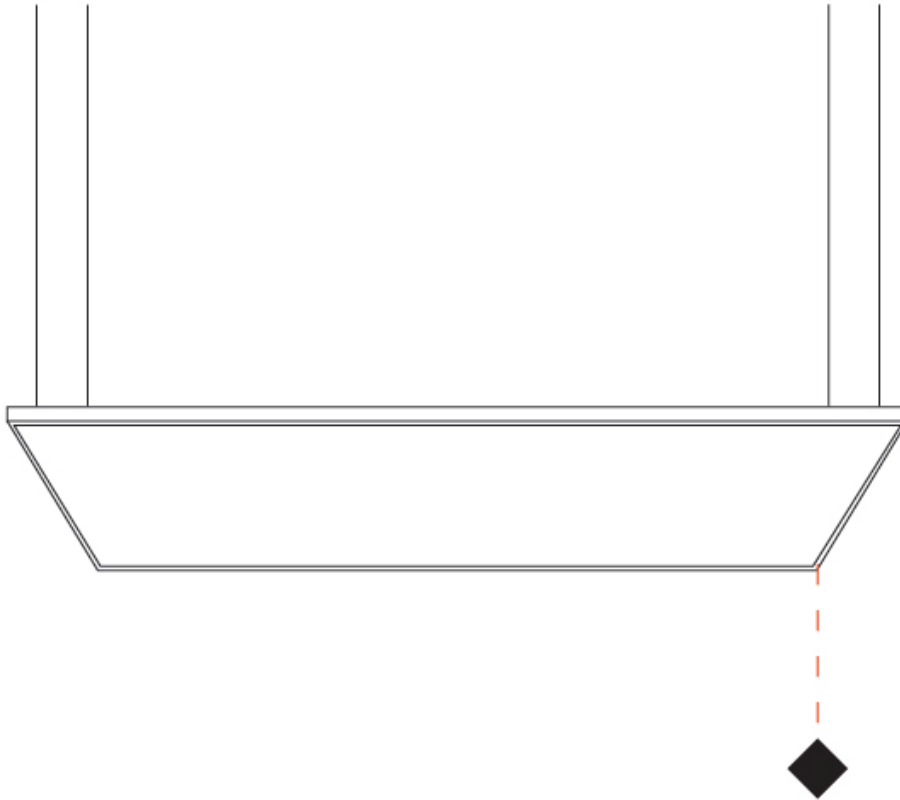

PROJECT	
TYPE	
SPECIFIER	
QUANTITY	
DATE	

HARMONY SQUARE SUSPENSION

A51079-

base number	Color	Finish	Diffuser
	Temperature	Options	Options

- To build a product code in our configurator select the specify button on the base model # product page
- To build a manual product code on this datasheet choose from the options listed below in blue font and add the suffix to the base model #

GENERAL

Series: Harmony Square
Partner: Ivela
Division: Architectural
Installation: Suspension
Product Type: Panels
Mounting Location: Ceiling
Light Distribution: Direct

PHYSICAL

Shape: Square
Length (mm): 1510
Length (in): 59 7/16"
Width (mm): 910
Width (in): 35 13/16"
Height (mm): 27
Height (in): 1 1/16"
Max. Overall Height (mm): 2500
Max. Overall Height (in): 98 7/16"
Diffuser: PMMA - Opal / Prismatic
Fixture Finish: WHI / BLK / GLD
Fixture Material: Aluminum

ELECTRICAL

Lamp Type: LED
Input Wattage (W): 60
Dimming: Tri-Mode (Non-Dimming and Phase Dimming (120Vac only) and 0-10V Dimming)
Driver Included: No
Driver Location: Remote
Driver Type: Constant Voltage - Universal
Driver Class: Class 2
Housing: ENCP 5 (ERP) ENCP 8 (SC Power)
Input Voltage (V): 120 - 277
Output Voltage (V): 24

LED

Color Temperature (°K): 2700 / 3000 / 3500 / 4000
Max. Delivered Lumen (lm): 4320 / 4500 / 4634 / 4770
Nominal Lumen (lm): 7200 / 7500 / 7950
CRI: >93 CRI
Lamp Life (hrs): 50000

OPTICAL

RATINGS AND CERTIFICATIONS

Certified By: Certified for North American Standards
IP rating: IP20

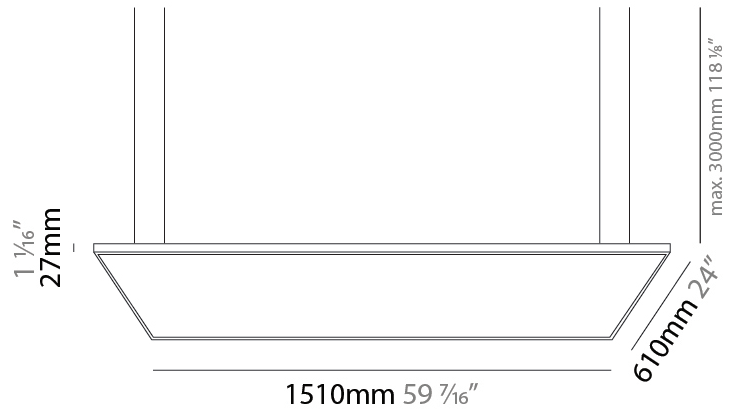

HARMONY SQUARE SUSPENSION

A51079-

PROJECT	_____
TYPE	_____
SPECIFIER	_____
QUANTITY	_____
DATE	_____

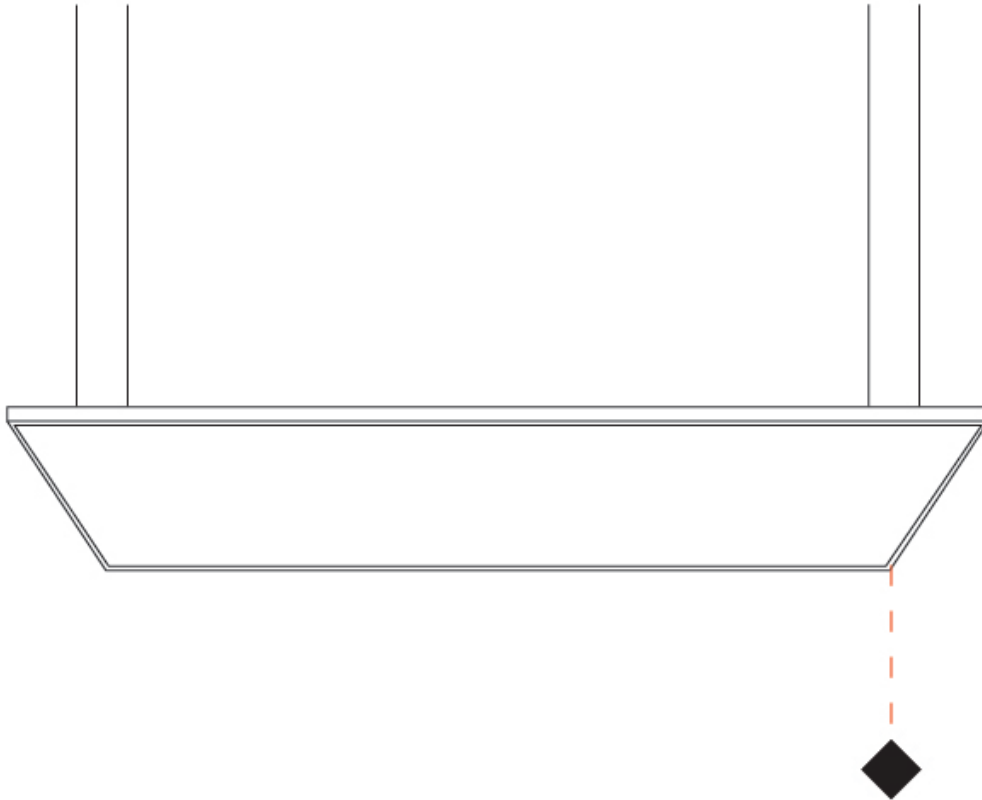

PROJECT _____
 TYPE _____
 SPECIFIER _____
 QUANTITY _____
 DATE _____

HARMONY SQUARE SUSPENSION

A51080-

base number Color Finish Diffuser
 Temperature Options Options

- To build a product code in our configurator select the specify button on the base model # product page
- To build a manual product code on this datasheet choose from the options listed below in blue font and add the suffix to the base model #

GENERAL

Series: Harmony Square
 Partner: Ivela
 Division: Architectural
 Installation: Suspension
 Product Type: Panels
 Mounting Location: Ceiling
 Light Distribution: Direct

PHYSICAL

Shape: Square
 Length (mm): 1810
 Length (in): 71 1/4
 Width (mm): 1110
 Width (in): 43 11/16
 Height (mm): 27
 Height (in): 1 1/16
 Max. Overall Height (mm): 2500
 Max. Overall Height (in): 98 7/16
 Diffuser: [PMMA - Opal / Prismatic](#)
 Fixture Finish: [WHI / BLK / GLD](#)
 Fixture Material: Aluminum

ELECTRICAL

Lamp Type: LED
 Input Wattage (W): 72
 Dimming: Tri-Mode (Non-Dimming and Phase Dimming (120Vac only) and 0-10V Dimming)
 Driver Included: No
 Driver Location: Remote
 Driver Type: Constant Voltage - Universal
 Driver Class: Class 2
 Housing: ENCP 5 (ERP) ENCP 8 (SC Power)
 Input Voltage (V): 120 - 277
 Output Voltage (V): 24

LED

Color Temperature (°K): [2700 / 3000 / 3500 / 4000](#)
 Max. Delivered Lumen (lm): 4320 / 4500 / 4634 / 4770
 Nominal Lumen (lm): 7200 / 7500 / 7950
 CRI: >93 CRI
 Lamp Life (hrs): 50000

OPTICAL

RATINGS AND CERTIFICATIONS

Certified By: Certified for North American Standards
 IP rating: IP20

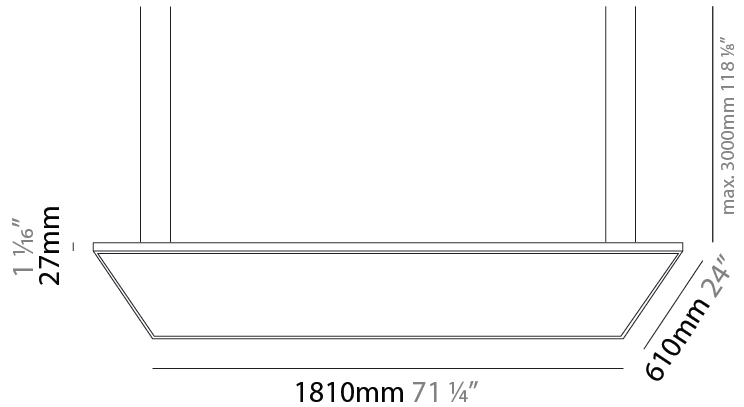

HARMONY SQUARE SUSPENSION

A51080-

PROJECT	_____
TYPE	_____
SPECIFIER	_____
QUANTITY	_____
DATE	_____

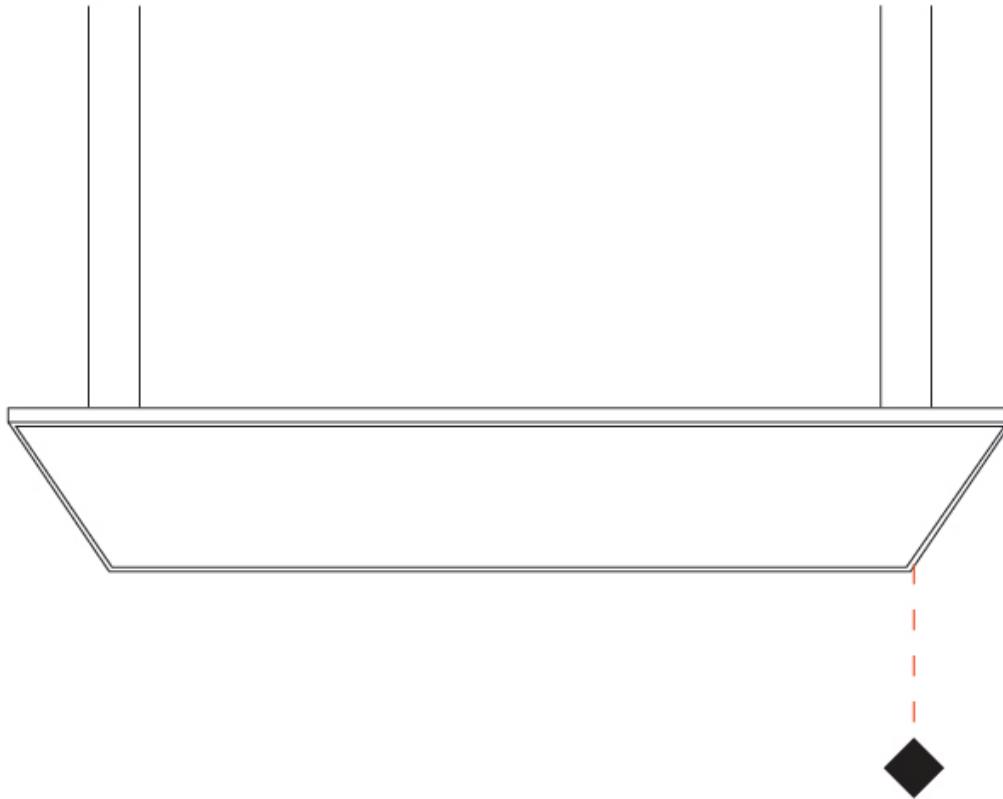

PROJECT	_____
TYPE	_____
SPECIFIER	_____
QUANTITY	_____
DATE	_____

HARMONY SQUARE SURFACE

A52046-

base number	Color	Finish	Diffuser
	Temperature	Options	Options

- To build a product code in our configurator select the specify button on the base model # product page
- To build a manual product code on this datasheet choose from the options listed below in blue font and add the suffix to the base model #

GENERAL

Series: Harmony Square
 Partner: Ivela
 Division: Architectural
 Installation: Surface
 Product Type: Panels
 Mounting Location: Ceiling
 Light Distribution: Direct

PHYSICAL

Shape: Square
 Length (mm): 610
 Length (in): 24
 Width (mm): 610
 Width (in): 24
 Height (mm): 27
 Height (in): 1 1/16
 Diffuser: PMMA - Opal
 Fixture Finish: WHI / BLK / GLD
 Fixture Material: Aluminum

ELECTRICAL

Lamp Type: LED
 Input Wattage (W): 48
 Dimming: Tri-Mode (Non-Dimming and Phase Dimming (120Vac only) and 0-10V Dimming)
 Driver Included: No
 Driver Location: Remote
 Driver Type: Constant Voltage - Universal
 Driver Class: Class 2
 Housing: ENCP 5 (ERP) ENCP 13 (SC Power)
 Input Voltage (V): 120 - 277
 Output Voltage (V): 24

LED

Color Temperature (°K): 2700 / 3000 / 4000
 Max. Delivered Lumen (lm): 3456 / 3600 / 3816
 Nominal Lumen (lm): 5760 / 6000 / 6360
 CRI: >93 CRI
 Lamp Life (hrs): 50000

OPTICAL

RATINGS AND CERTIFICATIONS

Certified By: CSA Certified to UL and CSA Standards
 IP rating: IP20

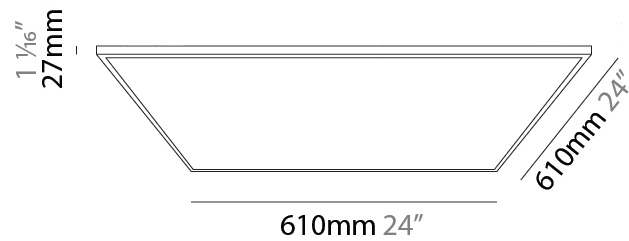
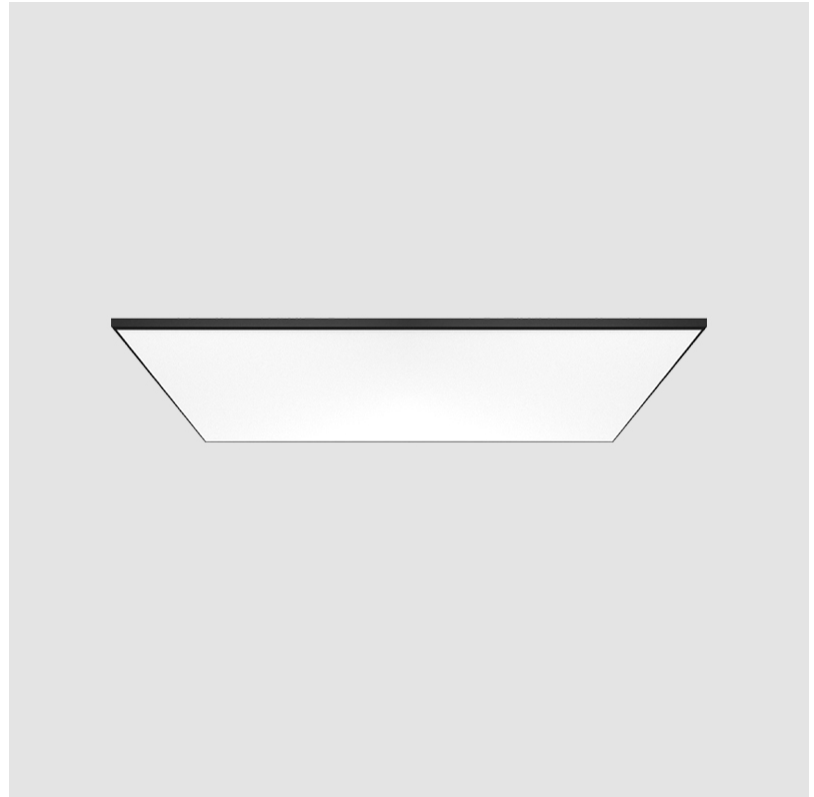

HARMONY SQUARE SURFACE

A52046-

PROJECT _____

TYPE _____

SPECIFIER _____

QUANTITY _____

DATE _____



PROJECT	_____
TYPE	_____
SPECIFIER	_____
QUANTITY	_____
DATE	_____

HARMONY SQUARE SURFACE

A52047-

base number	Color	Finish	Diffuser
	Temperature	Options	Options

- To build a product code in our configurator select the specify button on the base model # product page
- To build a manual product code on this datasheet choose from the options listed below in blue font and add the suffix to the base model #

GENERAL

Series: Harmony Square
Partner: Ivela
Division: Architectural
Installation: Surface
Product Type: Panels
Mounting Location: Ceiling
Light Distribution: Direct

PHYSICAL

Shape: Square
Length (mm): 910
Length (in): 35 ¹³ / ₁₆
Width (mm): 910
Width (in): 35 ¹³ / ₁₆
Height (mm): 27
Height (in): 1 ¹ / ₁₆
Diffuser: PMMA - Opal
Fixture Finish: WHI / BLK / GLD
Fixture Material: Aluminum

ELECTRICAL

Lamp Type: LED
Input Wattage (W): 72
Dimming: Tri-Mode (Non-Dimming and Phase Dimming (120Vac only) and 0-10V Dimming)
Driver Included: No
Driver Location: Remote
Driver Type: Constant Voltage - Universal
Driver Class: Class 2
Housing: ENCP 5 (ERP) ENCP 8 (SC Power)
Input Voltage (V): 120 - 277
Output Voltage (V): 24

LED

Color Temperature (°K): 2700 / 3000 / 4000
Max. Delivered Lumen (lm): 5184 / 5400 / 5724
Nominal Lumen (lm): 8640 / 9000 / 9540
CRI: >93 CRI
Lamp Life (hrs): 50000

OPTICAL

RATINGS AND CERTIFICATIONS

Certified By: CSA Certified to UL and CSA Standards
IP rating: IP20

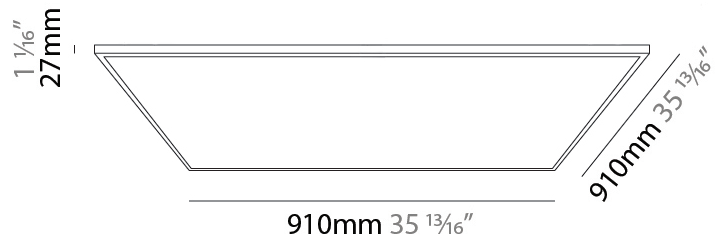
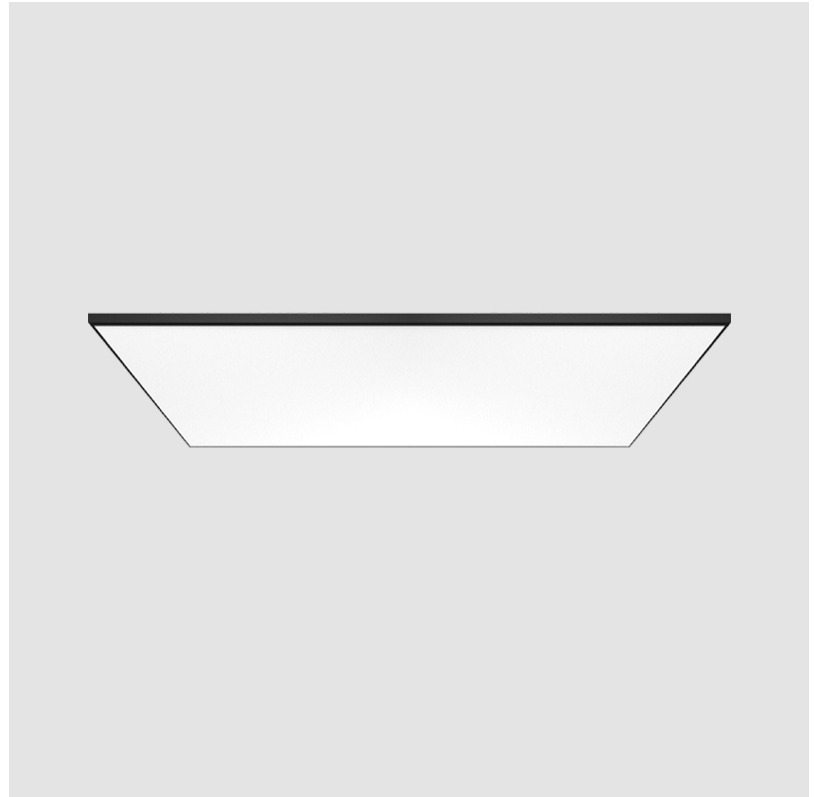

HARMONY SQUARE SURFACE

A52047-

PROJECT

TYPE

SPECIFIER

QUANTITY

DATE



PROJECT
TYPE
SPECIFIER
QUANTITY
DATE

HARMONY SQUARE SURFACE

A52048-

base number	Color	Finish	Diffuser
	Temperature	Options	Options

- To build a product code in our configurator select the specify button on the base model # product page
- To build a manual product code on this datasheet choose from the options listed below in blue font and add the suffix to the base model #

GENERAL

Series: Harmony Square
Partner: Ivela
Division: Architectural
Installation: Surface
Product Type: Panels
Mounting Location: Ceiling
Light Distribution: Direct

PHYSICAL

Shape: Square
Length (mm): 1110
Length (in): 43 11/16
Width (mm): 1110
Width (in): 43 11/16
Height (mm): 27
Height (in): 1 1/16
Diffuser: PMMA - Opal
Fixture Finish: WHI / BLK / GLD
Fixture Material: Aluminum

ELECTRICAL

Lamp Type: LED
Input Wattage (W): 80
Dimming: Tri-Mode (Non-Dimming and Phase Dimming (120Vac only) and 0-10V Dimming)
Driver Included: No
Driver Location: Remote
Driver Type: Constant Voltage - Universal
Driver Class: Class 2
Housing: ENCP 5 (ERP) ENCP 8 (SC Power)
Input Voltage (V): 120 - 277
Output Voltage (V): 24

LED

Color Temperature (°K): 2700 / 3000 / 4000
Max. Delivered Lumen (lm): 6336 / 6600 / 6996
Nominal Lumen (lm): 10560 / 11000 / 11660
CRI: >93 CRI
Lamp Life (hrs): 50000

OPTICAL

RATINGS AND CERTIFICATIONS

Certified By: CSA Certified to UL and CSA Standards
IP rating: IP20

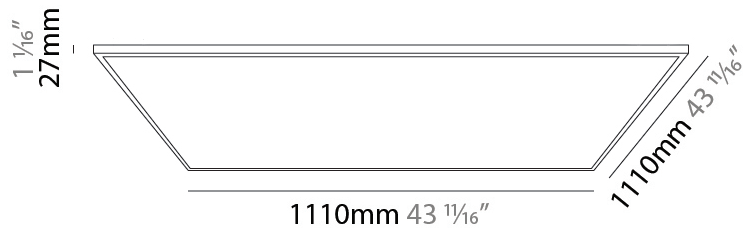
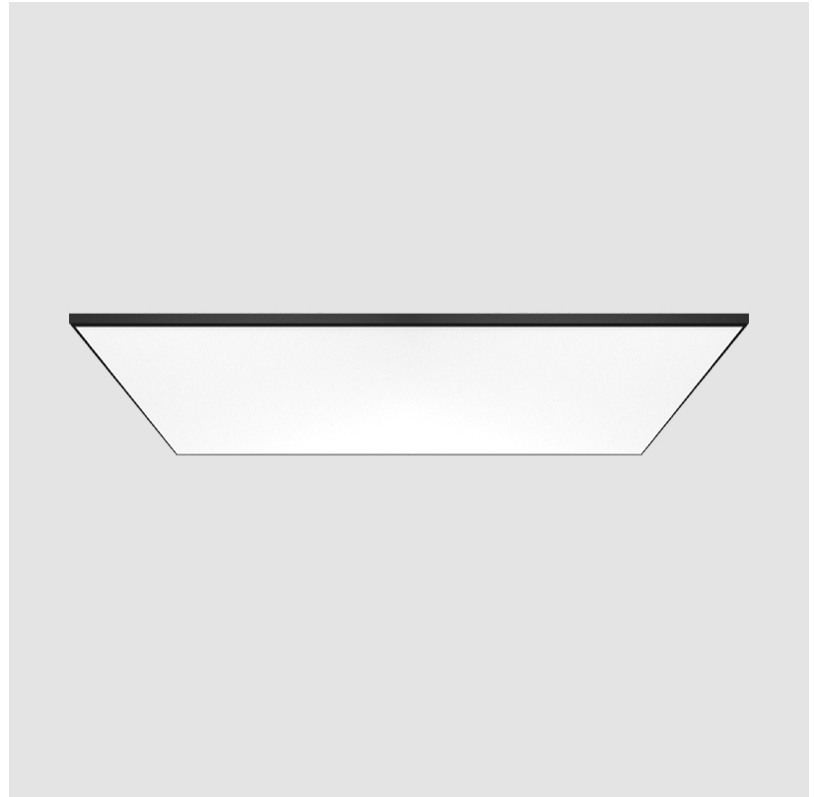

HARMONY SQUARE SURFACE

A52048-

PROJECT	_____
TYPE	_____
SPECIFIER	_____
QUANTITY	_____
DATE	_____



PROJECT	_____
TYPE	_____
SPECIFIER	_____
QUANTITY	_____
DATE	_____

HARMONY SQUARE SURFACE

A52049- - -
 base number Color Finish Diffuser
 Temperature Options Options

- To build a product code in our configurator select the specify button on the base model # product page
- To build a manual product code on this datasheet choose from the options listed below in blue font and add the suffix to the base model #

GENERAL

Series: Harmony Square
 Partner: Ivela
 Division: Architectural
 Installation: Surface
 Product Type: Panels
 Mounting Location: Ceiling
 Light Distribution: Direct

PHYSICAL

Shape: Square
 Length (mm): 1210
 Length (in): 47 5/8
 Width (mm): 610
 Width (in): 24
 Height (mm): 27
 Height (in): 1 1/16
 Diffuser: PMMA - Opal
 Fixture Finish: WHI / BLK / GLD
 Fixture Material: Aluminum

ELECTRICAL

Lamp Type: LED
 Input Wattage (W): 48
 Dimming: Tri-Mode (Non-Dimming and Phase Dimming (120Vac only) and 0-10V Dimming)
 Driver Included: No
 Driver Location: Remote
 Driver Type: Constant Voltage - Universal
 Driver Class: Class 2
 Housing: ENCP 5 (ERP) ENCP 13 (SC Power)
 Input Voltage (V): 120 - 277
 Output Voltage (V): 24

LED

Color Temperature (°K): 2700 / 3000 / 3500 / 4000
 Max. Delivered Lumen (lm): 3456 / 3600 / 3816
 Nominal Lumen (lm): 5760 / 6000 / 6178 / 6360
 CRI: >93 CRI
 Lamp Life (hrs): 50000

OPTICAL

RATINGS AND CERTIFICATIONS

Certified By: CSA Certified to UL and CSA Standards
 IP rating: IP20

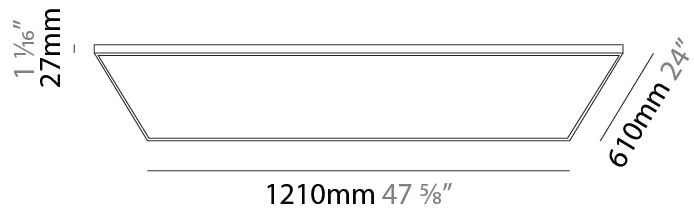
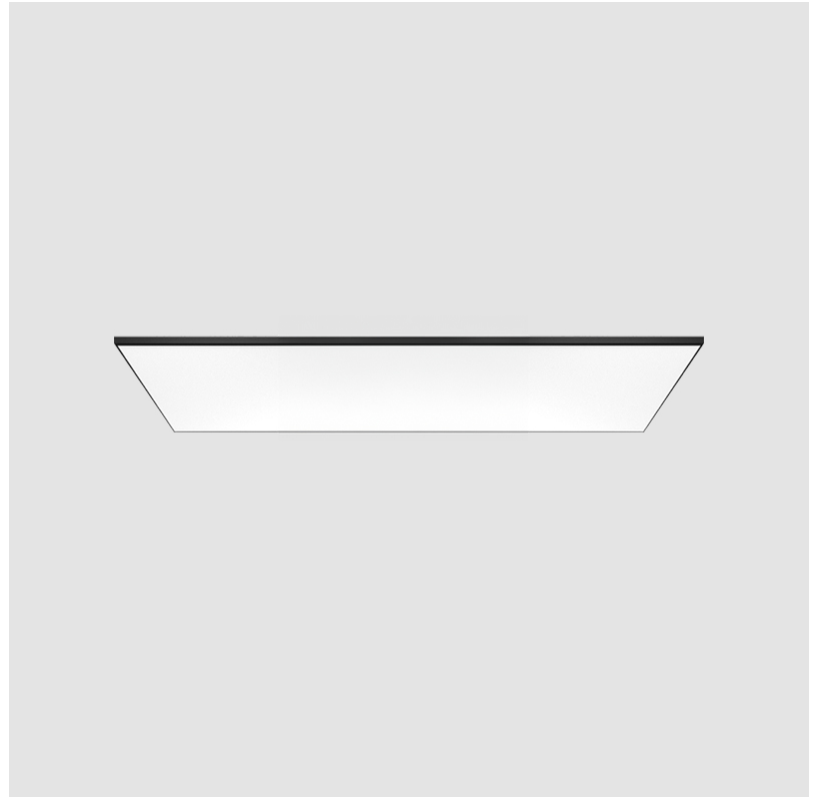

HARMONY SQUARE SURFACE

A52049-

PROJECT

TYPE

SPECIFIER

QUANTITY

DATE

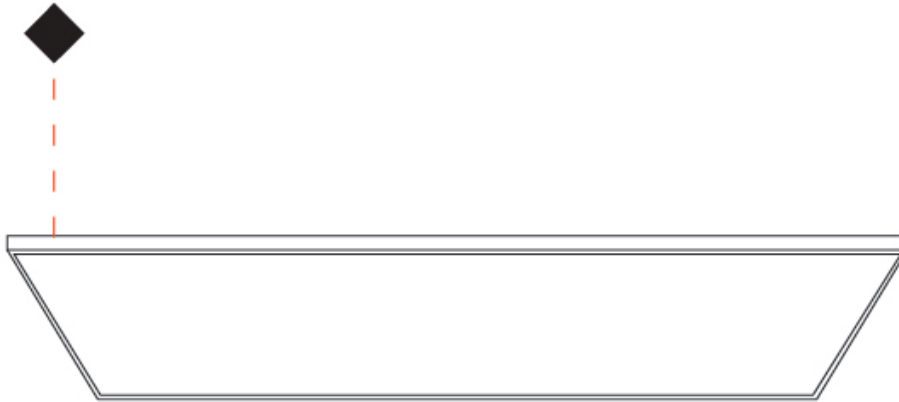

PROJECT	_____
TYPE	_____
SPECIFIER	_____
QUANTITY	_____
DATE	_____

HARMONY SQUARE SURFACE

A52050-

base number	Color	Finish	Diffuser
	Temperature	Options	Options

- To build a product code in our configurator select the specify button on the base model # product page
- To build a manual product code on this datasheet choose from the options listed below in blue font and add the suffix to the base model #

GENERAL

Series: Harmony Square
Partner: Ivela
Division: Architectural
Installation: Surface
Product Type: Panels
Mounting Location: Ceiling
Light Distribution: Direct

PHYSICAL

Shape: Square
Length (mm): 1510
Length (in): 59 7/16
Width (mm): 910
Width (in): 35 13/16
Height (mm): 27
Height (in): 1 1/16
Diffuser: PMMA - Opal
Fixture Finish: WHI / BLK / GLD
Fixture Material: Aluminum

ELECTRICAL

Lamp Type: LED
Input Wattage (W): 60
Dimming: Tri-Mode (Non-Dimming and Phase Dimming (120Vac only) and 0-10V Dimming)
Driver Included: No
Driver Location: Remote
Driver Type: Constant Voltage - Universal
Driver Class: Class 2
Housing: ENCP 5 (ERP) ENCP 8 (SC Power)
Input Voltage (V): 120 - 277
Output Voltage (V): 24

LED

Color Temperature (°K): 2700 / 3000 / 3500 / 4000
Max. Delivered Lumen (lm): 4320 / 4500 / 4634 / 4770
Nominal Lumen (lm): 7200 / 7500 / 7950
CRI: >93 CRI
Lamp Life (hrs): 50000

OPTICAL

RATINGS AND CERTIFICATIONS

Certified By: CSA Certified to UL and CSA Standards
IP rating: IP20

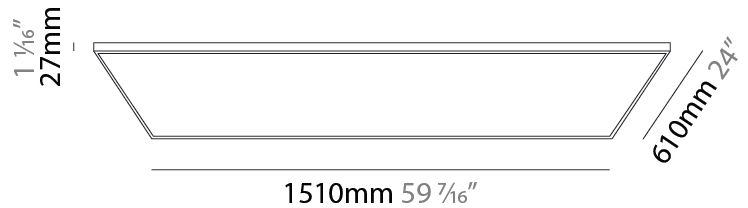
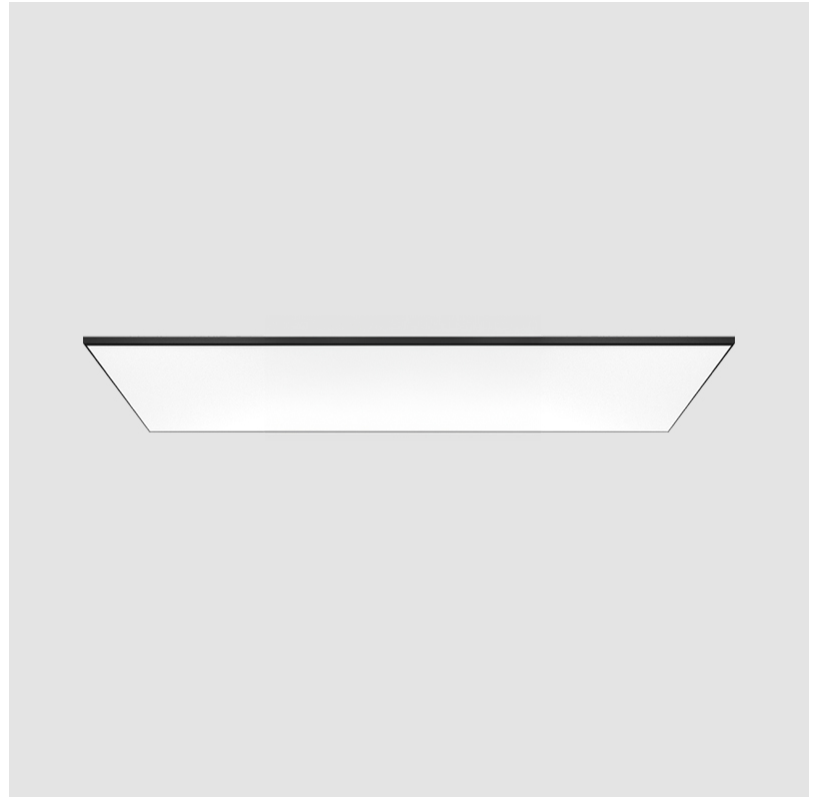

HARMONY SQUARE SURFACE

A52050-

PROJECT

TYPE

SPECIFIER

QUANTITY

DATE

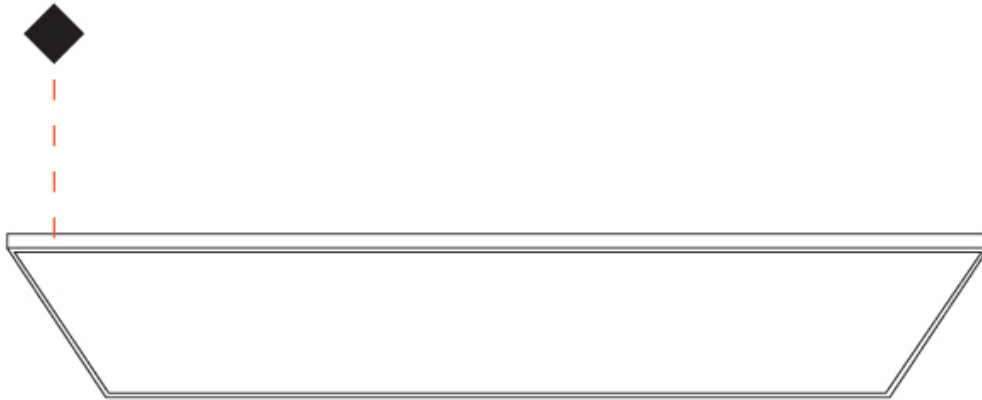

PROJECT	_____
TYPE	_____
SPECIFIER	_____
QUANTITY	_____
DATE	_____

HARMONY SQUARE SURFACE

A52051- - -
 base number Color Finish Diffuser
 Temperature Options Options

- To build a product code in our configurator select the specify button on the base model # product page
- To build a manual product code on this datasheet choose from the options listed below in blue font and add the suffix to the base model #

GENERAL

Series: Harmony Square
 Partner: Ivela
 Division: Architectural
 Installation: Surface
 Product Type: Panels
 Mounting Location: Ceiling
 Light Distribution: Direct

PHYSICAL

Shape: Square
 Length (mm): 1810
 Length (in): 71 1/4
 Width (mm): 610
 Width (in): 24
 Height (mm): 27
 Height (in): 1 1/16
 Diffuser: PMMA - Opal
 Fixture Finish: WHI / BLK / GLD
 Fixture Material: Aluminum

ELECTRICAL

Lamp Type: LED
 Input Wattage (W): 72
 Dimming: Tri-Mode (Non-Dimming and Phase Dimming (120Vac only) and 0-10V Dimming)
 Driver Included: No
 Driver Location: Remote
 Driver Type: Constant Voltage - Universal
 Driver Class: Class 2
 Housing: ENCP 5 (ERP) ENCP 8 (SC Power)
 Input Voltage (V): 120 - 277
 Output Voltage (V): 24

LED

Color Temperature (°K): 2700 / 3000 / 3500 / 4000
 Max. Delivered Lumen (lm): 4320 / 4500 / 4635 / 4770
 Nominal Lumen (lm): 7200 / 7500 / 7950
 CRI: >93 CRI
 Lamp Life (hrs): 50000

OPTICAL

RATINGS AND CERTIFICATIONS

Certified By: CSA Certified to UL and CSA Standards
 IP rating: IP20

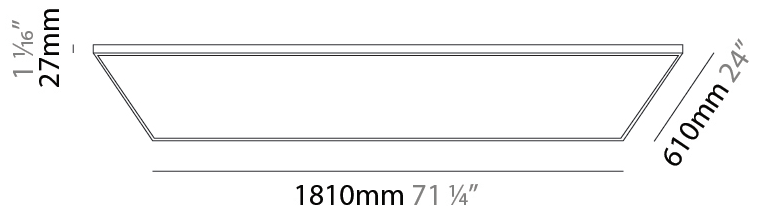
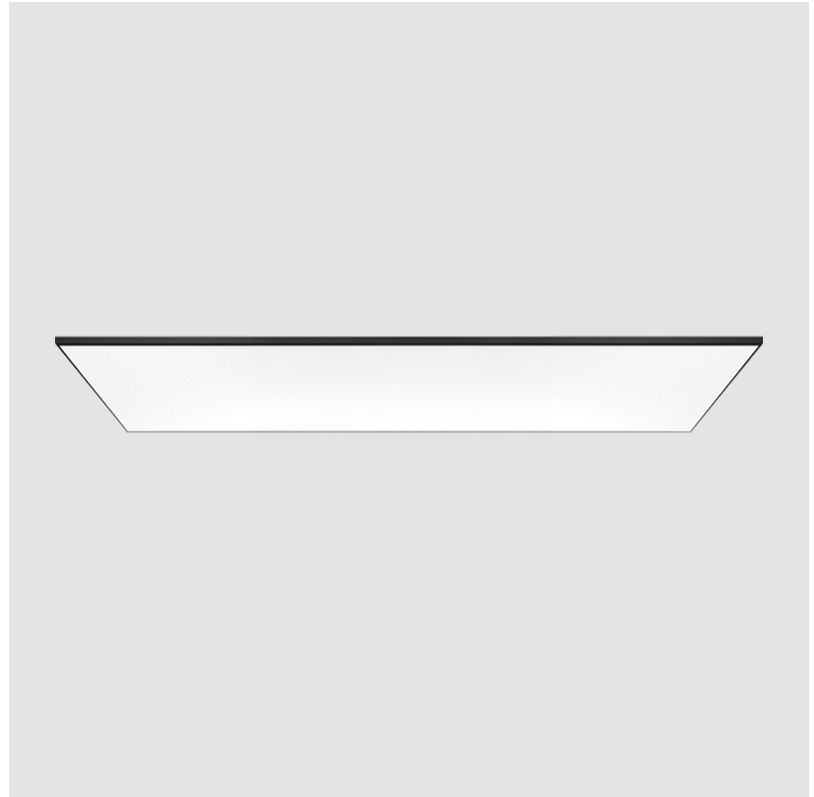

HARMONY SQUARE SURFACE

A52051-

PROJECT

TYPE

SPECIFIER

QUANTITY

DATE

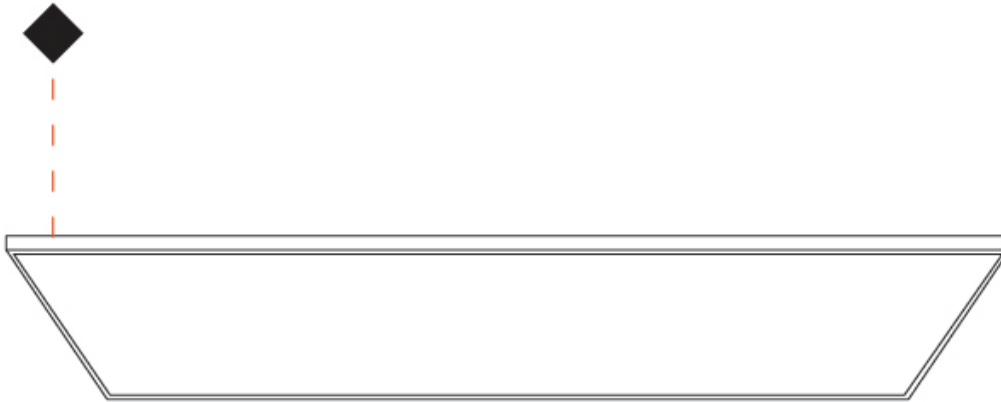

HARMONY SQUARE RECESSED

A56188- - -

base number Color Finish Diffuser
 Temperature Options Options

- To build a product code in our configurator select the specify button on the base model # product page
- To build a manual product code on this datasheet choose from the options listed below in blue font and add the suffix to the base model #

GENERAL

Series: Harmony Square
 Partner: Ivela
 Division: Architectural
 Installation: Recessed
 Product Type: Panels
 Mounting Location: Ceiling
 Light Distribution: Direct

PHYSICAL

Shape: Square
 Length (mm): 610
 Length (in): 24
 Width (mm): 610
 Width (in): 24
 Height (mm): 27
 Height (in): 1 1/16
 Diffuser: PMMA - Opal
 Fixture Finish: WHI / BLK / GLD
 Fixture Material: Aluminum

ELECTRICAL

Lamp Type: LED
 Input Wattage (W): 48
 Dimming: Tri-Mode (Non-Dimming and Phase Dimming (120Vac only) and 0-10V Dimming)
 Driver Included: No
 Driver Location: Remote
 Driver Type: Constant Voltage - Universal
 Driver Class: Class 2
 Housing: ENCP 5 (ERP) ENCP 13 (SC Power)
 Input Voltage (V): 120 - 277
 Output Voltage (V): 24

LED

Color Temperature (°K): 2700 / 3000 / 3500 / 4000
 Max. Delivered Lumen (lm): 3456 / 3600 / 3707 / 3816
 Nominal Lumen (lm): 5760 / 6000 / 6178 / 6360
 CRI: >93 CRI
 Lamp Life (hrs): 50000

OPTICAL

RATINGS AND CERTIFICATIONS

Certified By: CSA Certified to UL and CSA Standards
 IP rating: IP20

PROJECT
TYPE
SPECIFIER
QUANTITY
DATE

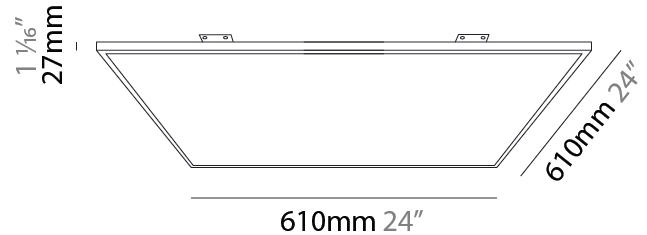

HARMONY SQUARE RECESSED

A56188-

PROJECT

TYPE

SPECIFIER

QUANTITY

DATE

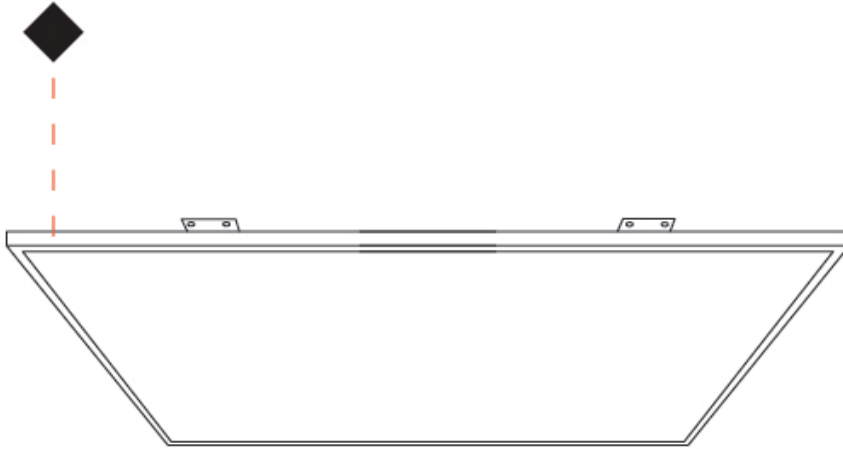

HARMONY SQUARE RECESSED

A56189-

base number Color Finish Diffuser
 Temperature Options Options

- To build a product code in our configurator select the specify button on the base model # product page
- To build a manual product code on this datasheet choose from the options listed below in blue font and add the suffix to the base model #

GENERAL

Series: Harmony Square
 Partner: Ivela
 Division: Architectural
 Installation: Recessed
 Product Type: Panels
 Mounting Location: Ceiling
 Light Distribution: Direct

PHYSICAL

Shape: Square
 Length (mm): 910
 Length (in): 35 ¹³/₁₆
 Width (mm): 910
 Width (in): 35 ¹³/₁₆
 Height (mm): 27
 Height (in): 1 ¹/₁₆
 Diffuser: PMMA - Opal
 Fixture Finish: WHI / BLK / GLD
 Fixture Material: Aluminum

ELECTRICAL

Lamp Type: LED
 Input Wattage (W): 72
 Dimming: Tri-Mode (Non-Dimming and Phase Dimming (120Vac only) and 0-10V Dimming)
 Driver Included: No
 Driver Location: Remote
 Driver Type: Constant Voltage - Universal
 Driver Class: Class 2
 Housing: ENCP 5 (ERP) ENCP 8 (SC Power)
 Input Voltage (V): 120 - 277
 Output Voltage (V): 24

LED

Color Temperature (°K): 2700 / 3000 / 3500 / 4000
 Max. Delivered Lumen (lm): 5184 / 5400 / 5560 / 5724
 Nominal Lumen (lm): 8640 / 9000 / 9268 / 9540
 CRI: >93 CRI
 Lamp Life (hrs): 50000

OPTICAL

RATINGS AND CERTIFICATIONS

Certified By: CSA Certified to UL and CSA Standards
 IP rating: IP20

PROJECT _____
 TYPE _____
 SPECIFIER _____
 QUANTITY _____
 DATE _____

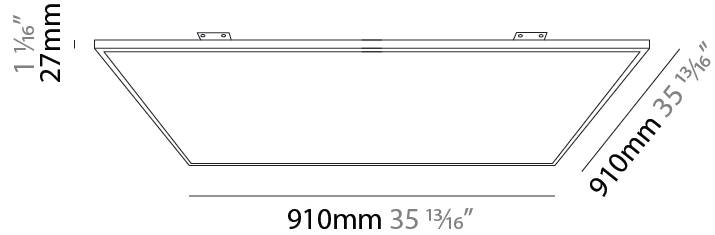
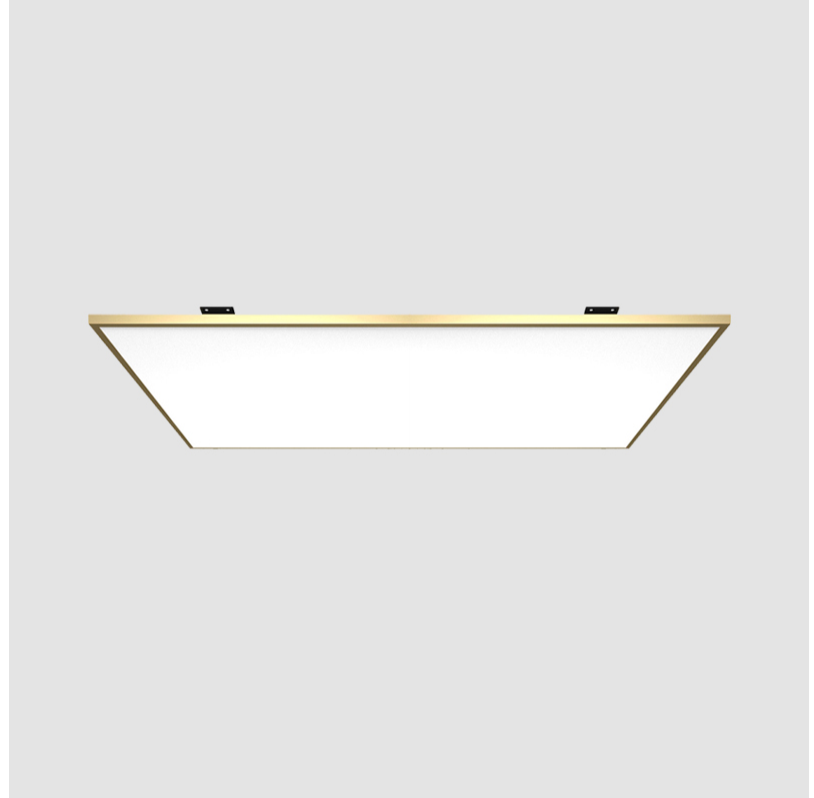

HARMONY SQUARE RECESSED

A56189-

PROJECT	_____
TYPE	_____
SPECIFIER	_____
QUANTITY	_____
DATE	_____

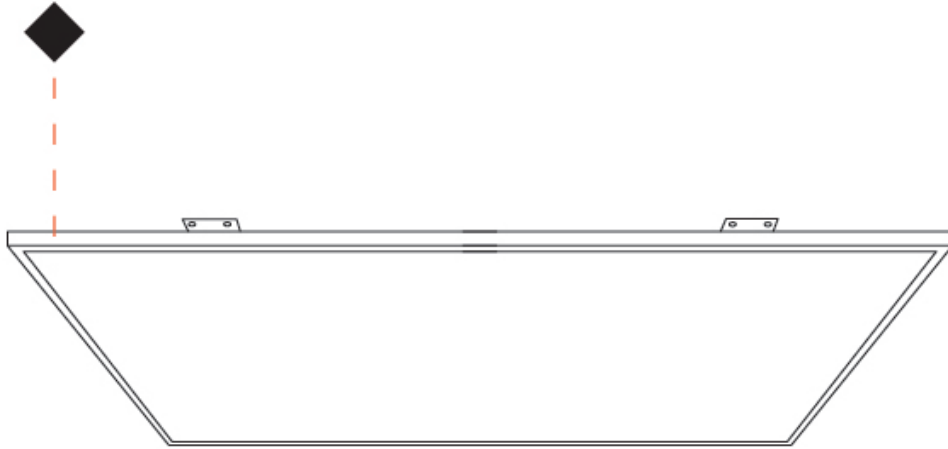

PROJECT	_____
TYPE	_____
SPECIFIER	_____
QUANTITY	_____
DATE	_____

HARMONY SQUARE RECESSED

A56190-

base number	Color	Finish	Diffuser
	Temperature	Options	Options

- To build a product code in our configurator select the specify button on the base model # product page
- To build a manual product code on this datasheet choose from the options listed below in blue font and add the suffix to the base model #

GENERAL

Series: Harmony Square
Partner: Ivela
Division: Architectural
Installation: Recessed
Product Type: Panels
Mounting Location: Ceiling
Light Distribution: Direct

PHYSICAL

Shape: Square
Length (mm): 1110
Length (in): 43 11/16
Width (mm): 1110
Width (in): 43 11/16
Height (mm): 27
Height (in): 1 1/16
Diffuser: PMMA - Opal
Fixture Finish: WHI / BLK / GLD
Fixture Material: Aluminum

ELECTRICAL

Lamp Type: LED
Input Wattage (W): 80
Dimming: Tri-Mode (Non-Dimming and Phase Dimming (120Vac only) and 0-10V Dimming)
Driver Included: No
Driver Location: Remote
Driver Type: Constant Voltage - Universal
Driver Class: Class 2
Housing: ENCP 5 (ERP) ENCP 8 (SC Power)
Input Voltage (V): 120 - 277
Output Voltage (V): 24

LED

Color Temperature (°K): 2700 / 3000 / 3500 / 4000
Max. Delivered Lumen (lm): 6336 / 6600 / 6796 / 6996
Nominal Lumen (lm): 10560 / 11000 / 11327 / 11660
CRI: >93 CRI
Lamp Life (hrs): 50000

OPTICAL

RATINGS AND CERTIFICATIONS

Certified By: CSA Certified to UL and CSA Standards
IP rating: IP20



HARMONY SQUARE RECESSED

A56190-

PROJECT _____

TYPE _____

SPECIFIER _____

QUANTITY _____

DATE _____



PROJECT _____

TYPE _____

SPECIFIER _____

QUANTITY _____

DATE _____

Fixture Finish

White - WHI

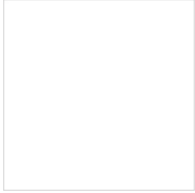

Black - BLK

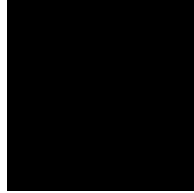

Gold - GLD



Digital: Not all screens are calibrated the same, and therefore, colors will appear differently between screens.











Physical: When texture is involved, there will be variations in color, character and tone within a product series and between product families.













LEGEND

 floor-mounted	 pivotable	 special LED (upon request) RGB, RGBW, tunable, gold+, meat+, art+, fashion+
 wall and ceiling: recessed and surface mounted	 rotating	 warm dim / natural dimming LED
 ceiling-mounted and wall-mounted	 illuminate tilted	 rechargeable battery powered
 wall-mounted	 color of suspension cable	 fixture with natural vivid LED (upon request)
 omni-directional light distribution	 length of suspension cable	 color rendering index
 direct light distribution	 reflector degree selection	 color temperature
 direct/indirect light distribution	 super spot	 lumen (luminous flux)
 indirect light distribution	 lens	 efficacy (lumens per watt)
 asymmetric light distribution	 lens pack	 Unified Glare Rating (UGR) range from 5-40
 aura light distribution	 shine ring	 marine grade (AISI 316 stainless steel)
 round wall or ceiling cut-out	 integrated shine ring with diffuser	 walk on
 square wall or ceiling cut-out	 free individual colors 01-29	 drive on
 the supplied jig specifies the cutout dimensions	 individual colors: 00 (free of charge), 01-25 (extra charge)	 Dark Sky Compliance
 minimum distance (meters) lamp - object	 luminaire part to be colored (F1)	 Americans with Disabilities Act (less than 4" off the wall located between 27"-84" from floor)
 recessed depth	 luminaire part to be colored (F2)	 lamp protected against explosion
 ceiling thickness in mm	 luminaire part to be colored (F3)	 blown glass using traditional methods by master glass blower
 ceiling thickness selection	 luminaire part to be colored (F4)	 acoustic material
 dimmable DP (phase), DV (0-10V), DD (dali), DS (step-dim)	 luminaire part to be colored (F5)	 protection class I, protection insulation
 included or excluded LED driver/transformer/control gear	 color of 3-circuit adaptor	 protection class II, protection insulation
 separately switchable	 indirect diffuser	 ETL Certified to UL and CSA Standards
 sensor	 direct diffuser	 UL Certified to UL and CSA Standards
 remote control	 ball-proof (upon request)	 CSA Certified to UL and CSA Standards
 available upon request	 accessory	 Certified for North American Standards

IP RATING

 IP20	protected against ingress of solid bodies greater than 12.5mm (finger)
 IP33	protected against ingress of solid bodies greater than 2.5mm protected against sprays of water up to 60 degrees from the vertical (rain)
 IP40	protected against ingress of solid bodies greater than 1mm (wire) no protection against the ingress of moisture
 IP43	protected against ingress of solid bodies greater than 1mm (wire) protected against sprays of water up to 60 degrees from the vertical (rain)
 IP44	protected against ingress of solid bodies greater than 1mm (wire) protected against water splashed from all directions
 IP54	protected against limited ingress of dust (wet rooms/covered outdoor areas) protected against water splashed from all directions
 IP65	protected against ingress of dust protected against jets of water
 IP66	protected against ingress of dust protected against powerful jets of water or heavy seas
 IP67	protected against ingress of dust protected against immersion of water between 15cm - 1m for 30 minutes
 IP68	protected against ingress of dust protected against immersion of water under pressure for long periods

IK RATING

 IK01	protected against 0.14 joules impact (equivalent to 0.25kg mass dropped from 56mm above the surface)
 IK02	protected against 0.2 joules impact (equivalent to 0.25kg mass dropped from 80mm above the surface)
 IK03	protected against 0.35 joules impact (equivalent to 0.25kg mass dropped from 140mm above the surface)
 IK04	protected against 0.5 joules impact (equivalent to 0.25kg mass dropped from 200mm above the surface)
 IK05	protected against 0.7 joules impact (equivalent to 0.25kg mass dropped from 280mm above the surface)
 IK06	protected against 1 joules impact (equivalent to 0.25kg mass dropped from 400mm above the surface)
 IK07	protected against 2 joules impact (equivalent to 0.5kg mass dropped from 400mm above the surface)
 IK08	protected against 5 joules impact (equivalent to 1.7kg mass dropped from 300mm above the surface)
 IK09	protected against 10 joules impact (equivalent to 5.0kg mass dropped from 200mm above the surface)
 IK10	protected against 20 joules impact (equivalent to 5.0kg mass dropped from 400mm above the surface)